

# LM3370

## Dual Synchronous Step-Down DC-DC Converter with Dynamic Voltage Scaling Function

### General Description

The LM3370 is a dual step-down DC-DC converter optimized for powering ultra-low voltage circuits from a single Li-Ion battery and input rail ranging from 2.7V to 5.5V. It provides two outputs with 600 mA load per channel. The output voltage range varies from 1V to 3.3V and can be dynamically controlled using the I<sup>2</sup>C compatible interface. This dynamic voltage scaling function allows processors to achieve maximum performance at the lowest power level. The I<sup>2</sup>C compatible interface can also be used to control auto PFM-PWM/PWM mode selection and other performance enhancing features.

The LM3370 offers superior features and performance for portable systems with complex power management requirements. Automatic intelligent switching between PWM low-noise and PFM low-current mode offers improved system efficiency. Internal synchronous rectification enhances the converter efficiency without the use of further external devices.

There is a power-on-reset function that monitors the level of the output voltage to avoid unexpected power losses. The independent enable pin for each output allows for simple and effective power sequencing.

LM3370 is available in a 4 mm by 5 mm 16-lead non-pullback LLP and a 20-Bump micro SMD, 3.0 mm x 2.0 mm x 0.6 mm, package. A high switching frequency—2 MHz (typ)—allows use of tiny surface-mount components including a 2.2  $\mu$ H inductor.

Default fixed voltages for the 2 output voltages combination can be customized to fit system requirements by contacting National Semiconductor Corporation.

### Features

- I<sup>2</sup>C compatible interface
  - $V_{OUT1} = 1V$  to 2V in 50 mV steps
  - $V_{OUT2} = 1.8V$  to 3.3V in 100 mV steps
  - Automatic PFM/PWM mode switching & Forced PWM mode for low noise operation
  - Spread Spectrum capability using I<sup>2</sup>C
- 600 mA load per channel
- 2 MHz PWM fixed switching frequency (typ.)
- Internal synchronous rectification for high efficiency
- Internal soft start
- Power-on-reset function for both outputs
- $2.7V \leq V_{IN} \leq 5.5V$
- Operates from a single Li-Ion cell or 3 cell NiMH/NiCd batteries and 3.3V/5.5V fixed rails
- 2.2  $\mu$ H Inductor, 4.7  $\mu$ F Input and 10  $\mu$ F Output Capacitor per channel
- 16-lead LLP Package (4 mm x 5 mm x 0.8 mm)
- 20-Bump micro SMD Package (3.0 mm x 2.0 mm x 0.6 mm)

### Applications

- Baseband Processors
- Application Processors (Video, Audio)
- I/O Power
- FPGA Power and CPLD

### Typical Performance Curve

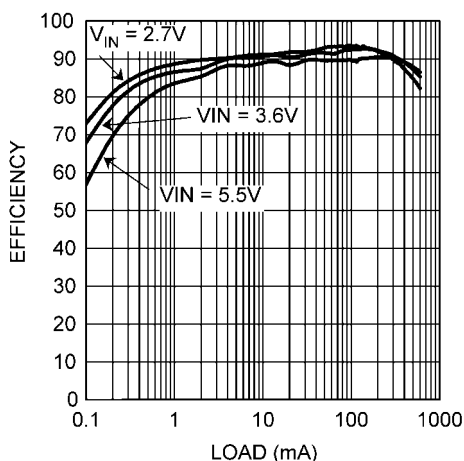

Efficiency vs. Output Current,  $V_{OUT1} = 1.2V$  20167381

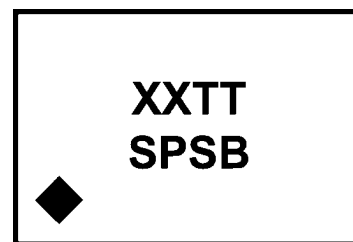

Dimensions: 3.0 mm x 2.0 mm x 0.60 mm 20167379

# Typical Application

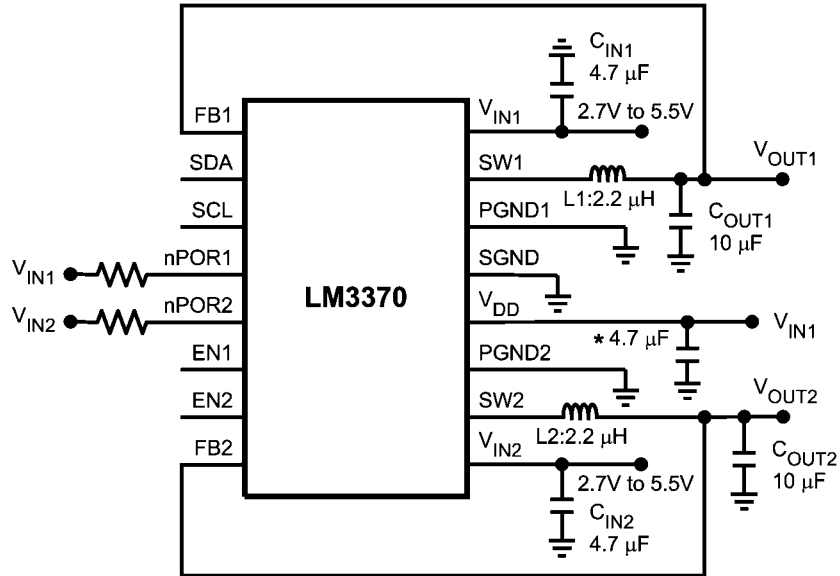

\* Optional Capacitor

20167301

FIGURE 1. Typical Application Circuit

# Functional Block Diagram

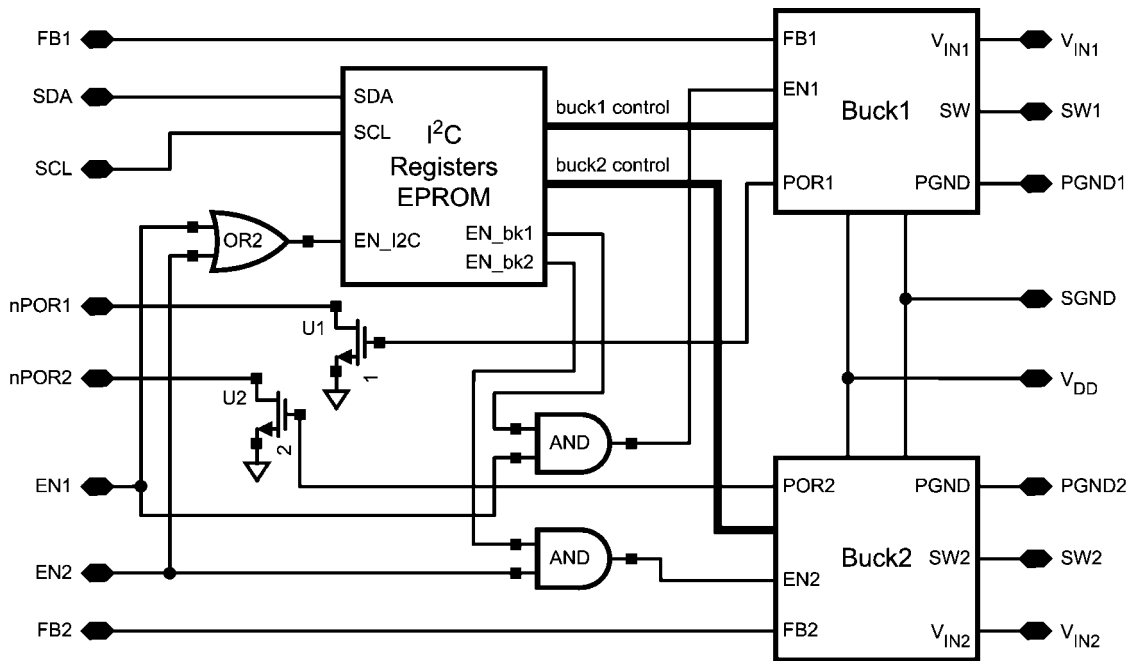

20167302

FIGURE 2. Functional Diagram

## Package Marking Information

16-Lead LLP Package

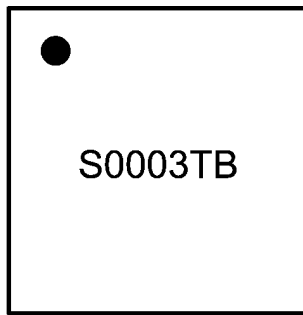

20167343

FIGURE 3. Top Marking

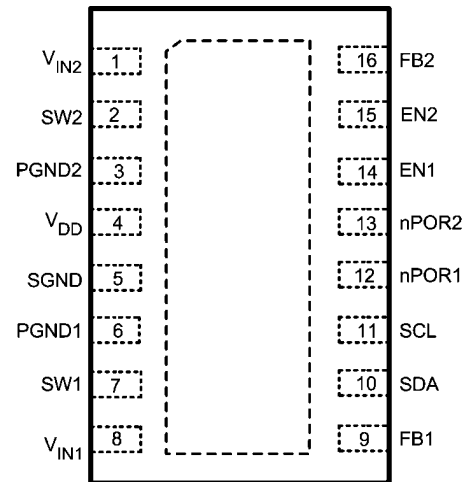

20167342

FIGURE 4. Top View

## Pin Descriptions (LLP)

Pin #	Name	Description
1	$V_{IN2}$	Power supply voltage input to PFET and NFET switches for Buck 2
2	SW2	Buck 2 Switch Pin
3	PGND2	Buck 2 Power Ground
4	$V_{DD}$	Signal supply voltage input, $V_{DD}$ must be equal or greater of the two inputs ( $V_{IN1}$ & $V_{IN2}$ )
5	SGND	Signal GND
6	PGND1	Buck 1 Power Ground
7	SW1	Buck 1 Switch Pin
8	$V_{IN1}$	Power supply voltage input to PFET and NFET switches for Buck 1
9	FB1	Analog Feedback Input for Buck 1
10	SDA	I <sup>2</sup> C Compatible Data, a 2 k $\Omega$ pull up resistor is required
11	SCL	I <sup>2</sup> C Compatible Clock, a 2 k $\Omega$ pull up resistor is required
12	nPOR1	Power ON Reset for Buck 1, Open drain output Low when Buck 1 output is 92% of target output. A 100 k $\Omega$ pull up resistor is required
13	nPOR2	Power ON Reset for Buck 2, Open drain output Low when Buck 2 output is 92% of target output. A 100 k $\Omega$ pull up resistor is required
14	EN1	Buck 1 Enable
15	EN2	Buck 2 Enable
16	FB2	Analog feedback for Buck 2

## Package Marking Information (micro SMD)

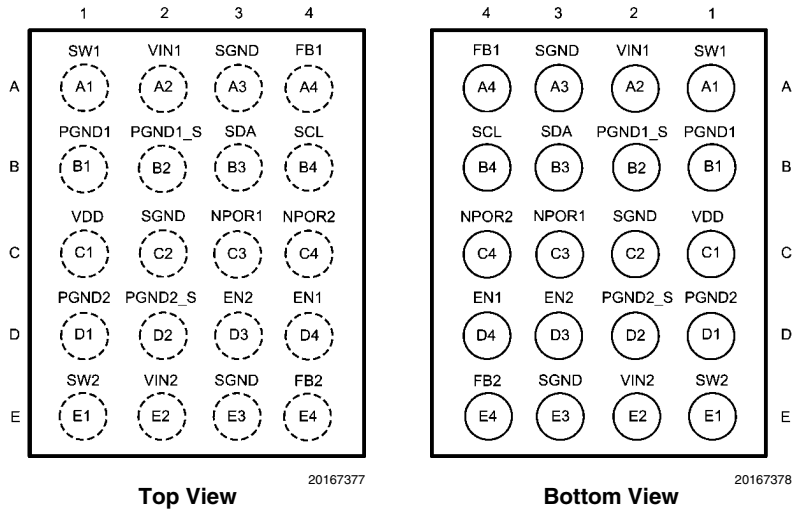

## Pin Descriptions (micro SMD)

Pin #	Name	Description
A1	SW1	Buck 1 Switch Pin
A2	$V_{IN1}$	Power supply voltage input to PFET and NFET switches for Buck 1
A3	SGND	Signal GND
A4	FB1	Analog Feedback Input for Buck 1
B1	PGND1	Buck 1 Power Ground
B2	PGND1_S	Buck 1 Power Ground Sense
B3	SDA	I <sup>2</sup> C Compatible Data, a 2 k $\Omega$ pull up resistor is required
B4	SCL	I <sup>2</sup> C Compatible Clock, a 2 k $\Omega$ pull up resistor is required
C1	$V_{DD}$	Signal supply voltage input, $V_{DD}$ must be equal or greater of the two inputs ( $V_{IN1}$ & $V_{IN2}$ )
C2	SGND	Signal GND
C3	nPOR1	Power ON Reset for Buck 1, Open drain output Low when Buck 1 output is 92% of target output. A 100 k $\Omega$ pull up resistor is required
C4	nPOR2	Power ON Reset for Buck 2, Open drain output Low when Buck 2 output is 92% of target output. A 100 k $\Omega$ pull up resistor is required
D1	PGND2	Buck 2 Power Ground
D2	PGND2_S	Buck 2 Power Ground Sense
D3	EN2	Buck 2 Enable
D4	EN1	Buck 1 Enable
E1	SW2	Buck 2 Switch Pin
E2	$V_{IN2}$	Power supply voltage input to PFET and NFET switches for Buck 2
E3	SGND	Signal GND
E4	FB2	Analog feedback for Buck 2

## I<sup>2</sup>C Controlled Features

Features	Parameter	Comments
Output Voltage	$V_{OUT1}$ & $V_{OUT2}$	Output voltage is controlled via I <sup>2</sup> C compatible
Modes	Buck 1 & Buck 2	Mode can be controlled via I <sup>2</sup> C compatible by either forcing device in Auto mode or forced PWM mode
Spread Spectrum	Buck 1 & Buck 2	Spread Spectrum capability via I <sup>2</sup> C compatible for noise reduction

## Ordering Information

### (LLP)

Order Number	Voltage Option	Package Marking	Supplied As
LM3370SD-3013	1.2V & 2.5V	S0003UB	1000 units, Tape-and-Reel
LM3370SDX-3013		S0003UB	4500 units, Tape and Reel
LM3370SD-3021	1.2V & 3.3V	S0003TB	1000 units, Tape-and-Reel
LM3370SDX-3021		S0003TB	4500 units, Tape-and-Reel
LM3370SD-3416	1.4V & 2.8V	S0003VB	1000 units, Tape-and-Reel
LM3370SDX-3416		S0003VB	4500 units, Tape-and-Reel
LM3370SD-3621	1.5V & 3.3V	S0004AB	1000 units, Tape-and-Reel
LM3370SDX-3621		S0004AB	4500 units, Tape-and-Reel
LM3370SD-3806	1.6V & 1.8V	S0003XB	1000 units, Tape-and-Reel
LM3370SDX-3806		S0003XB	4500 units, Tape-and-Reel
LM3370SD-4221	1.8V & 3.3V	S0003YB	1000 units, Tape-and-Reel
LM3370SDX-4221		S0003YB	4500 units, Tape-and-Reel

### (micro SMD)

Order Number	Voltage Option	Package Marking	Supplied As
LM3370TL-3607 NOPB	1.5V & 1.9V	SPSB	1000 units, Tape-and-Reel
LM3370TLX-3607 NOPB		SPSB	3000 units, Tape-and-Reel
LM3370TL-3008 NOPB	1.2V & 2.0V	SPTB	1000 units, Tape-and-Reel
LM3370TLX-3008 NOPB		SPTB	3000 units, Tape-and-Reel
LM3370TL-3006 NOPB	1.2V & 1.8V	SPUB	1000 units, Tape-and-Reel
LM3370TLX-3006 NOPB		SPUB	3000 units, Tape-and-Reel
LM3370TL-3806 NOPB	1.6V & 1.8V	SPVB	1000 units, Tape-and-Reel
LM3370TLX-3806 NOPB		SPVB	3000 units, Tape-and-Reel
LM3370TL-3206 NOPB	1.3V & 1.8V	SPXB	1000 units, Tape-and-Reel
LM3370TLX-3206 NOPB		SPXB	3000 units, Tape-and-Reel
LM3370TL-3022 NOPB	1.2V & 1.85V	STHB	1000 units, Tape-and-Reel
LM3370TLX-3022 NOPB		STHB	3000 units, Tape-and-Reel

Note the LM3370TL-3607 has the following default output voltages where  $V_{OUT1} = 1.5V$  &  $V_{OUT2} = 1.9V$

**Absolute Maximum Ratings** (Notes 1, 2)

If Military/Aerospace specified devices are required, please contact the National Semiconductor Sales Office/Distributors for availability and specifications.

$V_{IN1}, V_{IN2}$ VDD to PGND & SGND	-0.2V to 6V
PGND to SGND	-0.2V to +0.2V
SDA, SCL, EN, EN2, nPOR1, nPOR2, SW1, SW2, FB1 & FB2 (GND - 0.2) to ( $V_{IN} + 0.2V$ )	
Maximum Continuous Power Dissipation ( $P_{D\_MAX}$ ) (Note 3)	Internally Limited
Junction Temperature ( $T_{J\_MAX}$ )	125°C
Storage Temperature Range	-65°C to +150°C
Maximum Lead Temperature (Soldering)	(Note 4)

## ESD Ratings (Note 5)

All Pins

2 kV HBM  
200V MM**Operating Ratings** (Notes 1, 2)

Input Voltage Range ((Note 10))	2.7V to 5.5V
Recommended Load Current Per Channel	0 mA to 600 mA
Junction Temperature ( $T_J$ ) Range	-30°C to +125°C
Ambient Temperature ( $T_A$ ) Range (Note 6)	-30°C to +85°C

**Thermal Properties** (Note 7)

Junction-to-Ambient Thermal Resistance	
$\theta_{JA}$ (LLP-16)	26°C/W
$\theta_{JA}$ (20-Bump micro SMD)	50°C/W

**Electrical Characteristics** (Notes 2, 8, 10) Typical limits appearing in normal type apply for  $T_J = 25^\circ\text{C}$ . Limits appearing in boldface type apply over the entire junction temperature range ( $T_A = T_J = -30^\circ\text{C}$  to  $+85^\circ\text{C}$ ). Unless otherwise noted,  $V_{IN1} = V_{IN2} = 3.6V$ .

Symbol	Parameter	Conditions	Min	Typ	Max	Units
$V_{FB}$	Feedback Voltage	(Note 11)	<b>-3.5</b>		<b>+3.5</b>	%
$V_{OUT}$	Line Regulation	$2.7V \leq V_{IN} \leq 5.5V$ $I_O = 10\text{ mA}, V_{OUT} = 1.8V$		0.031		%/V
	Load Regulation	$100\text{ mA} \leq I_O \leq 600\text{ mA}$ $V_{IN} = 3.6V, V_{OUT} = 1.8V$		0.0013		%/mA
$I_Q$ PFM	Quiescent Current "On"	PFM Mode, Both Bucks ON		34		$\mu\text{A}$
$I_Q$ SD	Quiescent Current "Off"	EN1 = EN2 = 0V		0.2	<b>3</b>	$\mu\text{A}$
$I_{LIM}$	Peak Switching Current Limit	$V_{IN} = 3.6V$	<b>850</b>	1200	<b>1400</b>	mA
$R_{DS\_ON}$ (LLP)	PFET	$V_{IN} = 3.6V, I_{SW} = 200\text{ mA}$		390	500	m $\Omega$
	NFET	$V_{IN} = 3.6V, I_{SW} = 200\text{ mA}$		240	350	
$R_{DS\_ON}$ (micro SMD)	PFET	$V_{IN} = 3.6V, I_{SW} = 200\text{ mA}$		350	400	m $\Omega$
	NFET	$V_{IN} = 3.6V, I_{SW} = 200\text{ mA}$		170	210	
$F_{OSC}$	Internal Oscillator Frequency		<b>1.5</b>	2.0	<b>2.4</b>	MHz
$I_{EN}$	Enable (EN) Input Current			0.01	<b>1</b>	$\mu\text{A}$
$V_{IL}$	Enable Logic Low				<b>0.4</b>	V
$V_{IH}$	Enable Logic High		<b>1.0</b>			V
<b>POWER ON RESET THRESHOLD/FUNCTION (POR)</b>						
nPOR1 & nPOR2 Delay Time	nPOR1 = Power ON Reset for Buck 1 nPOR2 = Power ON Reset for Buck 2	50 mS (default)  Can be pre-trimmed to 50 $\mu\text{S}$ , 100 mS & 200 mS		50		mS
POR Threshold	Percentage of Target $V_{OUT}$	$V_{OUT}$ Rising		94		%
		$V_{OUT}$ Falling, 85% (default), Can be pre-trimmed to 70% or 94%		85		

**Note 1:** Absolute Maximum Ratings are limits beyond which damage to the device may occur. Operating Ratings are conditions under which operation of the device is guaranteed. Operating Ratings do not imply guaranteed performance limits. For guaranteed performance limits and associated test conditions, see the Electrical Characteristics tables.

**Note 2:** All voltages are with respect to the potential at the GND pin.

**Note 3:** Internal thermal shutdown circuitry protects the device from permanent damage. The thermal shutdown engages at  $T_J = 150^\circ\text{C}$  (typ.) and disengages at  $T_J = 140^\circ\text{C}$  (typ.).

**Note 4:** For detailed soldering specifications and information, please refer to National Semiconductor Application Note 1187: Leadless Leadframe Package (LLP) (AN-1187).

**Note 5:** The Human body model is a 100 pF capacitor discharged through a 1.5 k $\Omega$  resistor into each pin. (MIL-STD-883 3015.7) The machine model is a 200 pF capacitor discharged directly into each pin. (EAIJ)

**Note 6:** In applications where high power dissipation and/or poor package thermal resistance is present, the maximum ambient temperature may have to be derated. Maximum ambient temperature ( $T_{A-MAX}$ ) is dependent on the maximum operating junction temperature ( $T_{J-MAX-OP} = 125^\circ\text{C}$ ), the maximum power dissipation of the device in the application ( $P_{D-MAX}$ ), and the junction-to-ambient thermal resistance of the part/package in the application ( $\theta_{JA}$ ), as given by the following equation:  $T_{A-MAX} = T_{J-MAX-OP} - (\theta_{JA} \times P_{D-MAX})$ .

**Note 7:** Junction-to-ambient thermal resistance ( $\theta_{JA}$ ) is taken from a thermal modeling result, performed under the conditions and guidelines set forth in the JEDEC standard JESD51-7. The test board is a 4-layer FR-4 board measuring 102 mm x 76 mm x 1.6 mm with a 2 x 1 array of thermal vias. Thickness of copper layers are 2/1/1/2oz.

Junction-to-ambient thermal resistance is highly application and board-layout dependent. In applications where high maximum power dissipation exists, special care must be paid to thermal dissipation issues in board design.

The value of  $\theta_{JA}$  of this product can vary significantly, depending on PCB material, layout, and environmental conditions. In applications where high maximum power dissipation exists (high  $V_{IN}$ , high  $I_{OUT}$ ), special care must be paid to thermal dissipation issues. For more information on these topics, please refer to *Application Note 1187: Leadless Leadframe Package (LLP)* and the *Power Efficiency and Power Dissipation* section of this datasheet.

**Note 8:** Min. and Max are guaranteed by design, test and/or statistical analysis. All electrical characteristics having room-temperature limits are tested during production with  $T_J = 25^\circ\text{C}$ . All hot and cold limits are guaranteed by correlating the electrical characteristics to process and temperature variations and applying statistical process control.

**Note 9:** Guaranteed by design.

**Note 10:** Input voltage range for all voltage options is 2.7V to 5.5V. The voltage range recommended for the specified output voltages:

$$V_{IN} = 2.7V \text{ to } 5.5V \text{ for } 1V \leq V_{OUT} \leq 1.7V \text{ and for } V_{OUT} = 1.8V \text{ or greater, } V_{IN} = V_{OUT} + 1V$$

or

$$V_{IN,MIN} = I_{LOAD} * (R_{DS(on),PFET} + R_{DCR,INDUCTOR}) + V_{OUT}$$

**Note 11:** Test condition: for  $V_{OUT}$  less than 2.5V,  $V_{IN} = 3.6V$ ; for  $V_{OUT}$  greater than or equal to 2.5V,  $V_{IN} = V_{OUT} + 1V$ .

## Dissipation Rating Table

$\theta_{JA}$	$T_A = 60^\circ\text{C}$ Power Rating	$T_A = 85^\circ\text{C}$ Power Rating
26°C/W (4-Layer Board) LLP-16		1538 mW
50°C/W (4-Layer Board) 20-bump micro SMD	1300 mW	800 mW

**Typical Performance Characteristics** LM3370SD/TL, Circuit of *Figure 1*,  $V_{IN} = 3.6V$ ,  $V_{OUT1} = 1.5V$  &  $V_{OUT2} = 2.5V$ ,  $L = 2,2 \mu H$  (NR3015T2R2M),  $C_{IN} = 4.7 \mu F$  (0805) and  $C_{OUT} = 10 \mu F$  (0805) &  $T_A = 25^\circ C$ , unless otherwise noted.

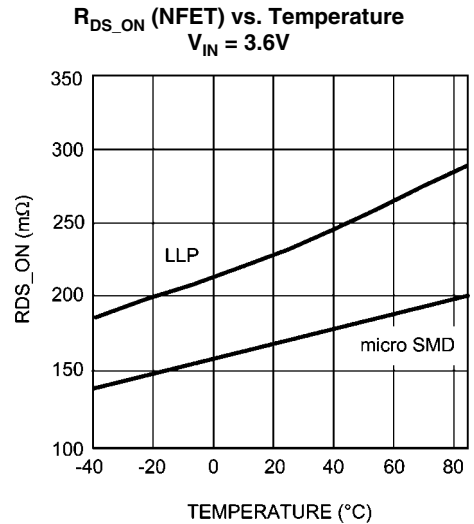
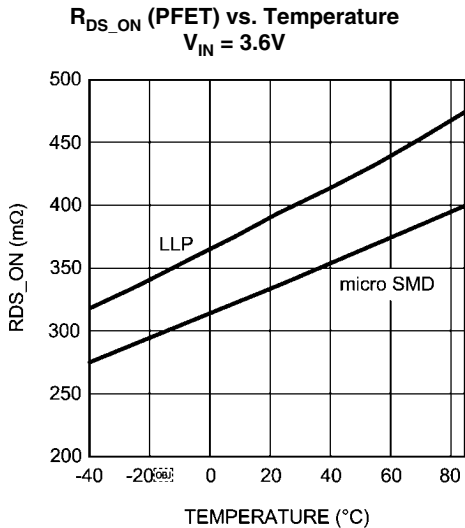
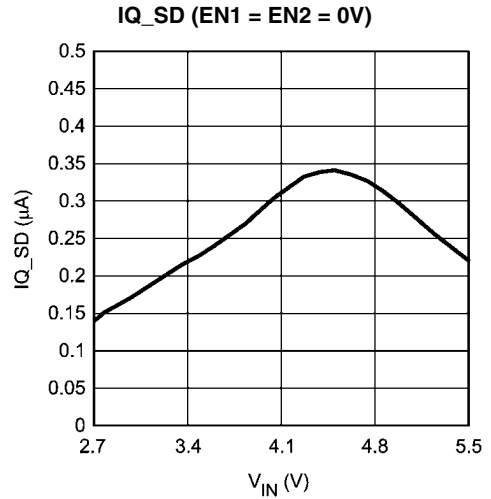
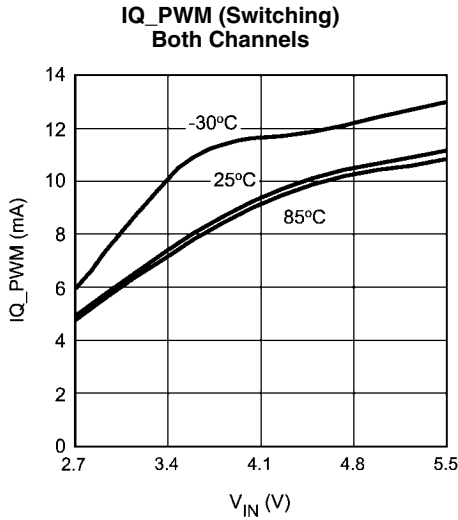
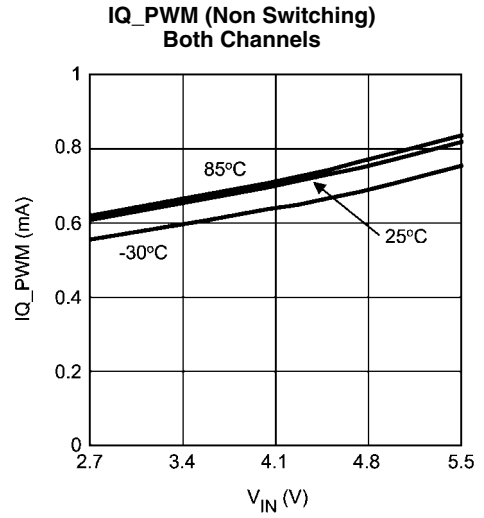
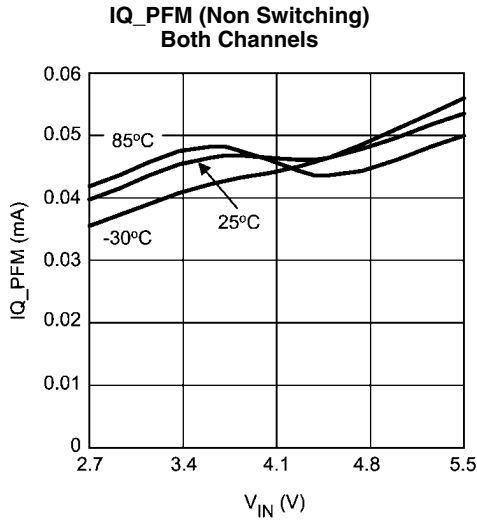



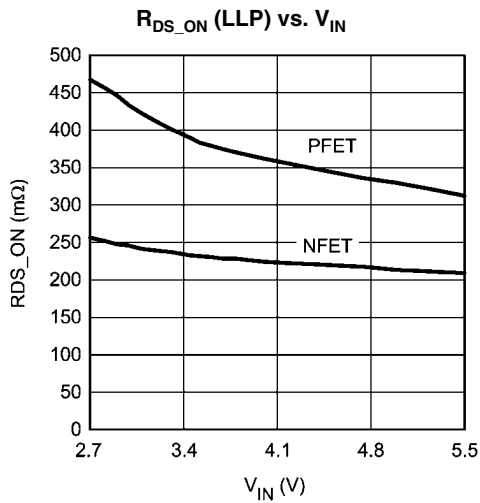

20167348

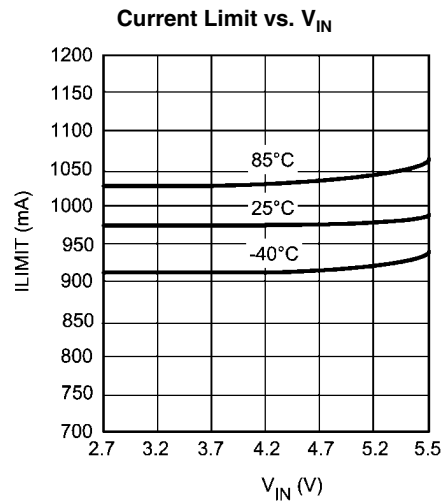

20167353

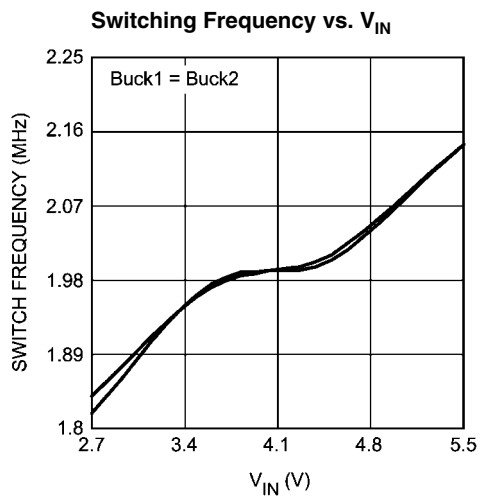

20167360

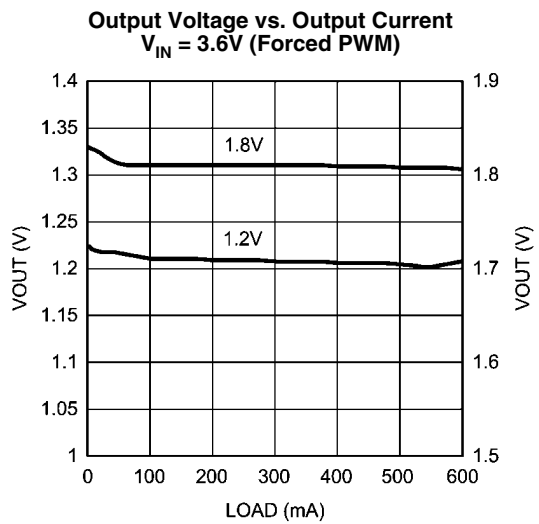

20167370

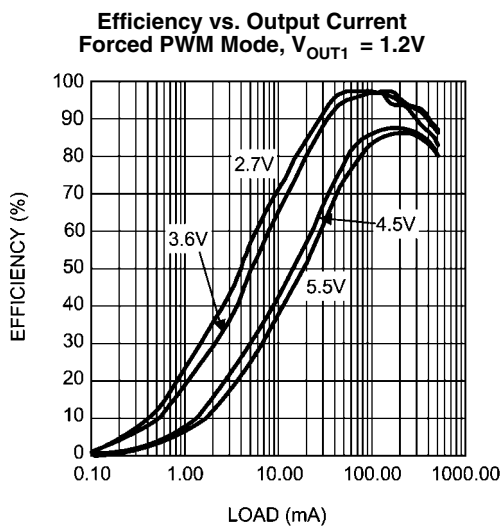

20167362

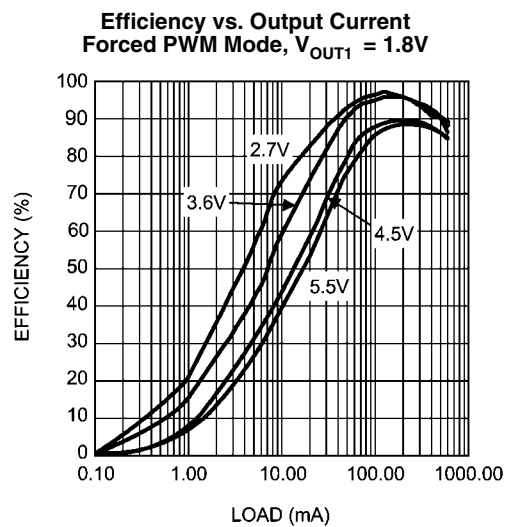

20167363

**Efficiency vs. Output Current**  
Auto Mode,  $V_{OUT1} = 1.5V$

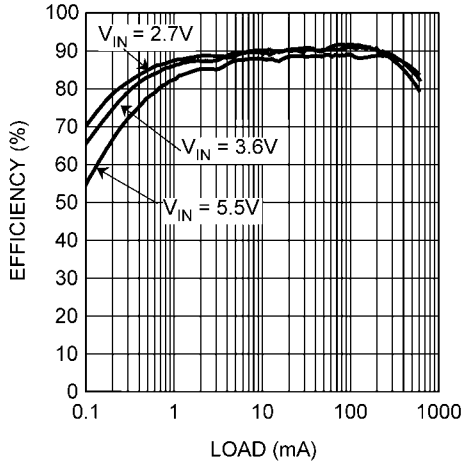

20167380

**Efficiency vs. Output Current**  
Auto Mode,  $V_{OUT2} = 1.9V$

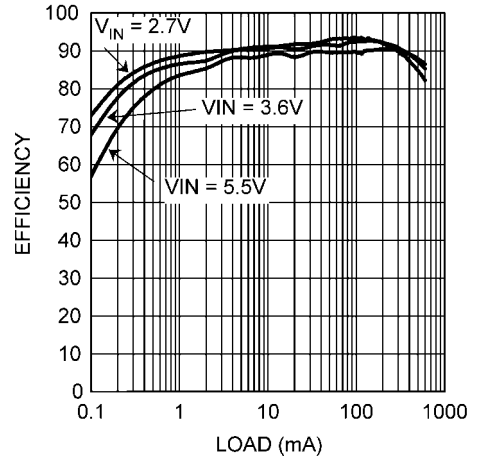

20167381

**Efficiency vs. Output Current**  
Auto Mode,  $V_{OUT2} = 3.3V$

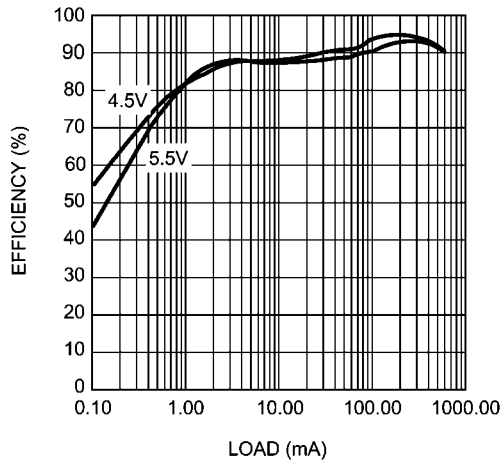

20167367

**Efficiency vs. Output Current**  
Forced PWM Mode,  $V_{OUT2} = 3.3V$

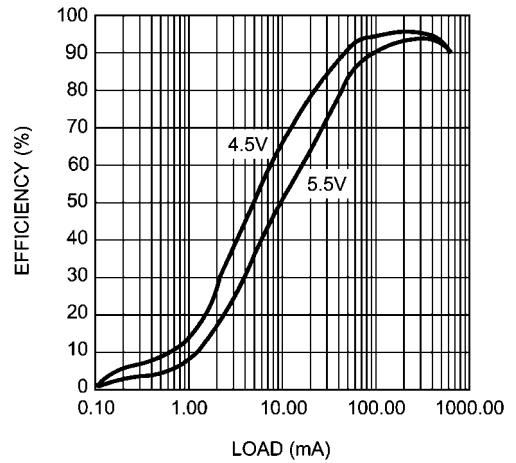

20167366

**Typical Operation Waveform**  
 $V_{IN} = 3.6V$ ,  $V_{OUT1} = 1.8V$  &  $V_{OUT2} = 1.8V$   
Load = 400 mA

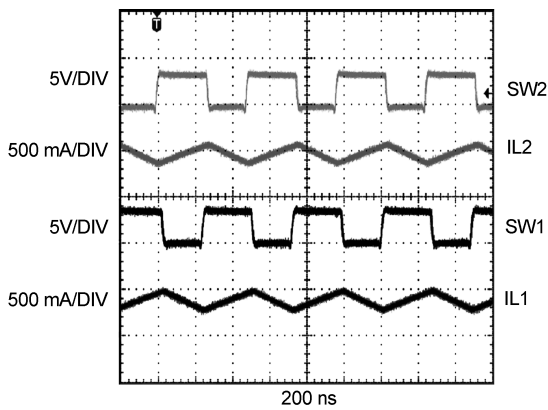

20167320

**Typical Operation Waveform**  
 $V_{IN} = 4.8V$ ,  $V_{OUT1} = 1V$  &  $V_{OUT2} = 3.3V$   
Load = 400 mA

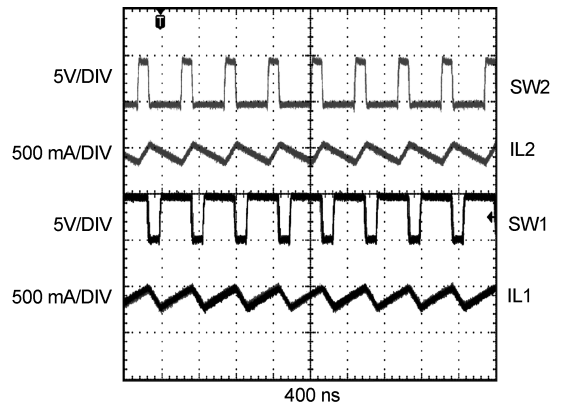

20167321

**Typical Operation Waveform**  
 $V_{IN} = 3.6V$ ,  $V_{OUT1} = 1.5V$ ,  $V_{OUT2} = 2.5V$ ,  
 Load = 600 mA Each

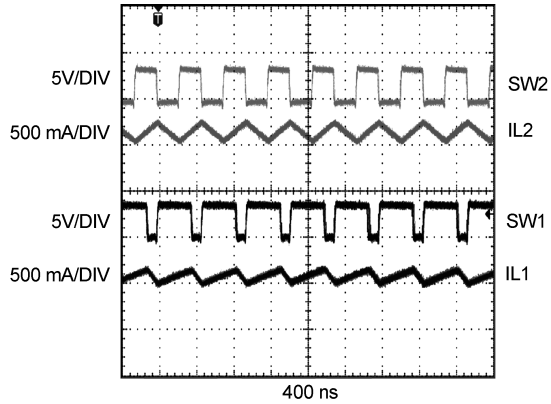

20167322

**Start-up at PWM for BUCK1**  
 ( $V_{IN} = 3.6V$ ,  $V_{OUT} = 1.5V$ , Load = 200 mA)

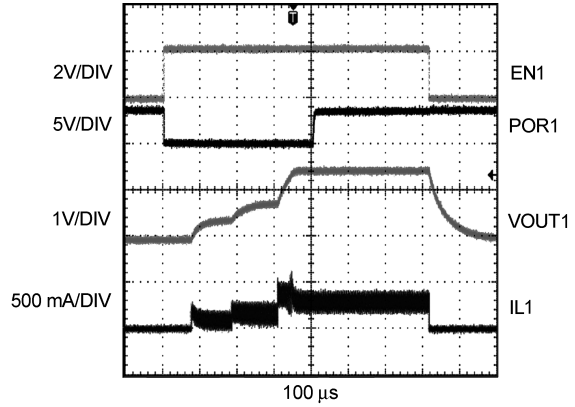

20167327

**Start-up at PWM for BUCK2**  
 ( $V_{IN} = 3.6V$ ,  $V_{OUT} = 2.5V$ , Load = 200 mA)

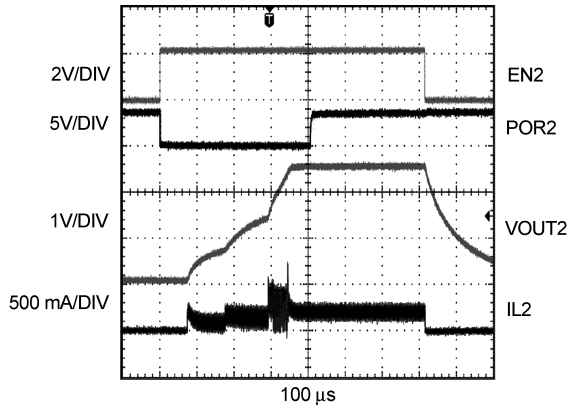

20167325

**Line Transient**  
 ( $V_{OUT1} = 1.2V$ )

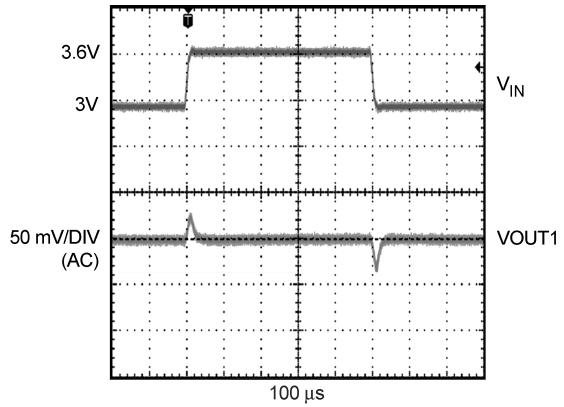

20167330

**Line Transient**  
 ( $V_{OUT2} = 1.8V$ )

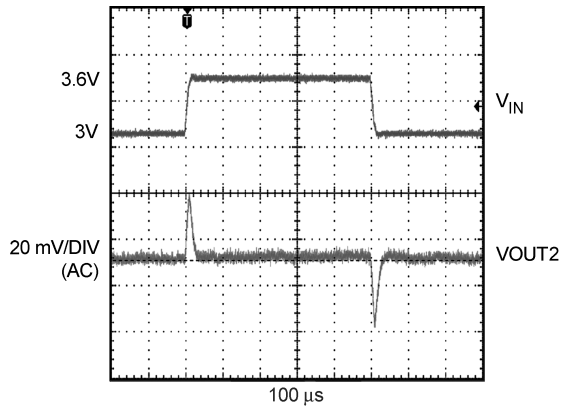

20167331

**Load Transient in PFM MODE**  
 ( $V_{OUT1} = 1.5V$ )

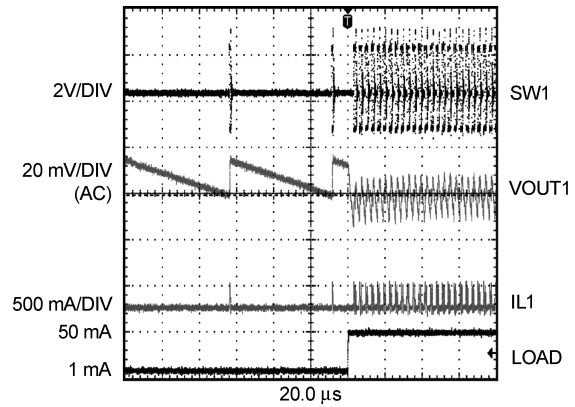

20167332

**Load Transient in PFM MODE**  
( $V_{OUT1} = 1.5V$ )

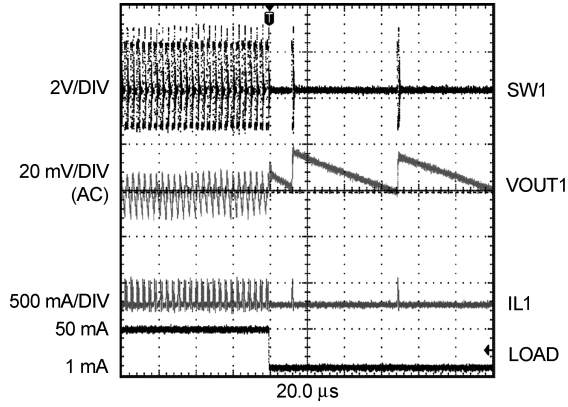

20167333

**Load Transient in PFM MODE**  
( $V_{OUT1} = 1.8V$ )

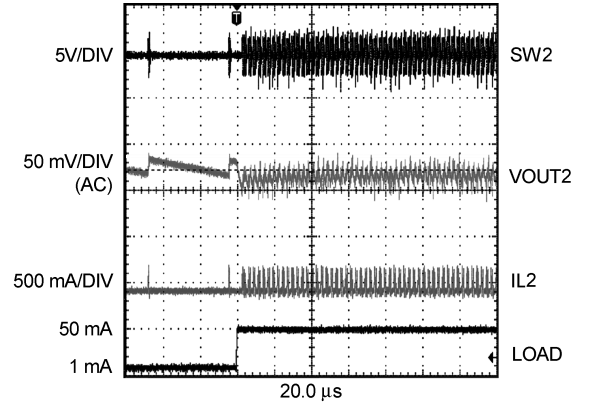

20167334

**Load Transient in PFM MODE** ( $V_{OUT1} = 1.8V$ )

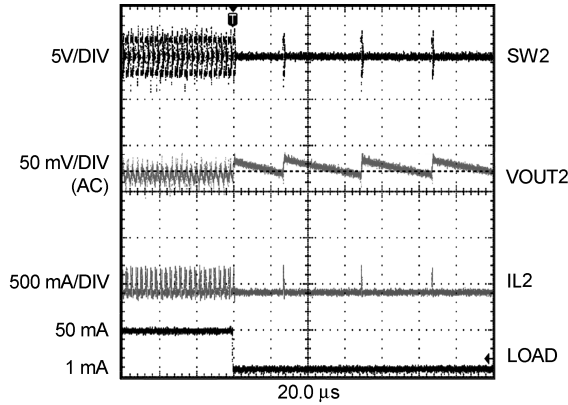

20167335

**Load Transient in PWM MODE**  
( $V_{IN} = 3.6V, V_{OUT1} = 1.2V$ )

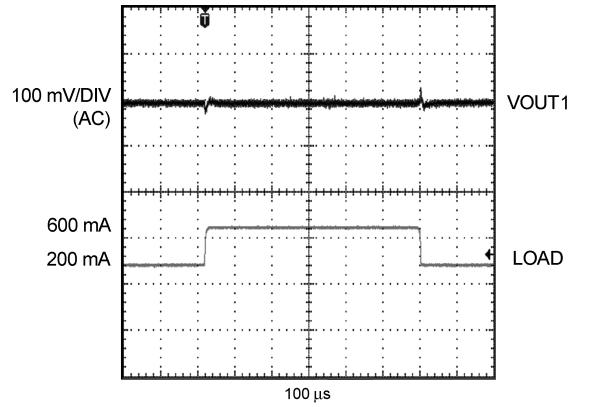

20167338

**Load Transient in PWM MODE**  
( $V_{IN} = 3.6V, V_{OUT1} = 1.5V$ )

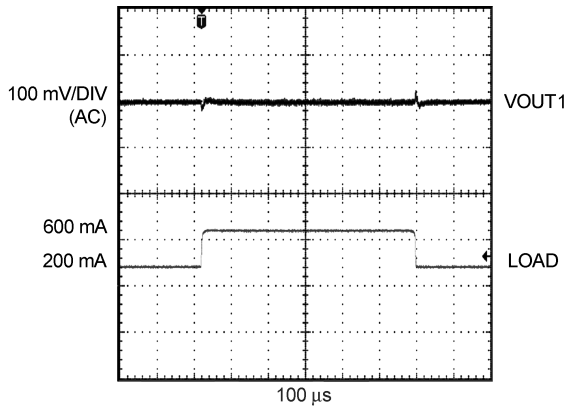

20167339

**Load Transient in PWM MODE**  
( $V_{IN} = 3.6V, V_{OUT2} = 2.5V$ )

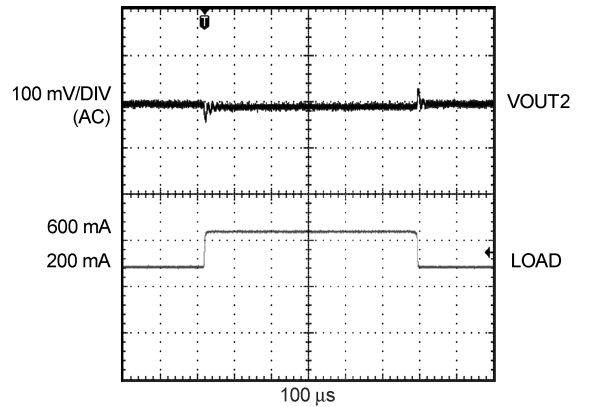

20167341

**Spread Spectrum Enabling**  
( $V_{OUT}$  Signal at 2 MHz)

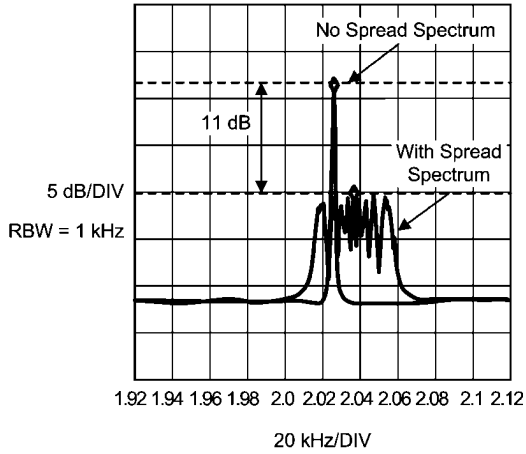

20167375

**$V_{OUT}$  Stepping**  
(From 1.8V to 3.3V)

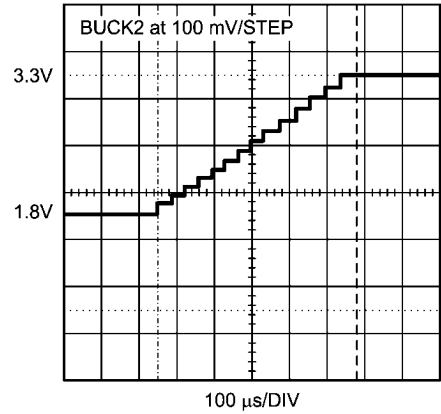

20167371

**$V_{OUT}$  Stepping**  
(From 3.3V to 1.8V)

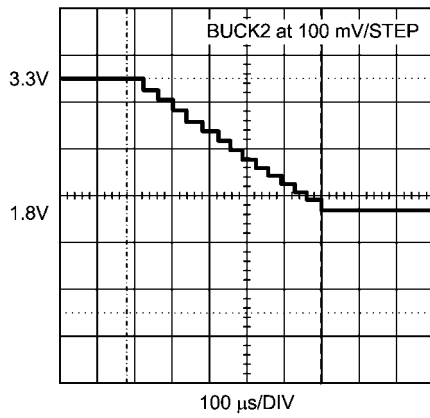

20167372

## Operation Description

### DEVICE INFORMATION

The LM3370, a dual high efficiency step down DC-DC converter, delivers regulated voltages from input rails between 2.7V to 5.5V. Using voltage mode architecture with synchronous rectification, the LM3370 has the ability to deliver up to 600 mA per channel. The performance is optimized for systems where efficiency and space are critical.

There are three modes of operation depending on the current required—PWM, PFM, and shutdown. PWM mode handles loads of approximately 70 mA or higher with 90% efficiency or better. Lighter loads cause the device to automatically switch into PFM mode to maintain high efficiency with low supply current ( $I_Q = 20 \mu\text{A typ.}$ ) per channel.

The LM3370 can operate up to a 100% duty cycle (PFET switch always on) for low drop out control of the output voltage. In this way the output voltage will be controlled down to the lowest possible input voltage.

Additional features include soft-start, under voltage lock out, current overload protection, and thermal overload protection.

### CIRCUIT OPERATION

During the first portion of each switching cycle, the control block in the LM3370 turns on the internal PFET switch. This allows current to flow from the input through the inductor to the output filter capacitor and load. The inductor limits the current to a ramp with a slope of

$$\frac{V_{IN} - V_{OUT}}{L}$$

by storing energy in a magnetic field. During the second portion of each cycle, the controller turns the PFET switch off, blocking current flow from the input, and then turns the NFET synchronous rectifier on. The inductor draws current from ground through the NFET to the output filter capacitor and load, which ramps the inductor current down with a slope of

$$\frac{-V_{OUT}}{L}$$

The output filter stores charge when the inductor current is high, and releases it when low, smoothing the voltage across the load.

### PWM OPERATION

During PWM operation the converter operates as a voltage-mode controller with input voltage feed forward. This allows the converter to achieve excellent load and line regulation. The DC gain of the power stage is proportional to the input voltage. To eliminate this dependence, feed forward inversely proportional to the input voltage is introduced.

### INTERNAL SYNCHRONOUS RECTIFICATION

While in PWM mode, the LM3370 uses an internal NFET as a synchronous rectifier to reduce rectifier forward voltage drop and associated power loss. Synchronous rectification provides a significant improvement in efficiency whenever the output voltage is relatively low compared to the voltage drop across an ordinary rectifier diode.

### CURRENT LIMITING

A current limit feature allows the LM3370 to protect itself and external components during overload conditions. PWM mode implements cycle-by-cycle current limiting using an internal comparator that trips at 1200 mA (typ.). If the outputs are shorted to ground the device enters a timed current limit mode where the NFET is turned on for a longer duration until the inductor current falls below a low threshold, ensuring inductor has more time to decay, thereby preventing runaway.

### PFM OPERATION

At very light loads, the converter enters PFM mode and operates with reduced switching frequency and supply current to maintain high efficiency.

The part will automatically transition into PFM mode when either of two conditions are true, for a duration of 32 or more clock cycles:

1. The NFET current reaches zero.
2. The peak PFET switch current drops below the  $I_{MODE}$  level.

$$\text{(Typically } I_{MODE} < 66 \text{ mA} + \frac{V_{IN}}{160\Omega}\text{)}$$

Supply current during this PFM mode is less than 20  $\mu\text{A}$  per channel, which allows the part to achieve high efficiency under extremely light load conditions. When the output drops below the 'low' PFM threshold, the cycle repeats to restore the output voltage to  $\sim 1.2\%$  above the nominal PWM output voltage.

If the load current should increase during PFM mode (see *Figure 5*) causing the output voltage to fall below the 'low2' PFM threshold, the part will automatically transition into fixed-frequency PWM mode.

During PFM operation, the converter positions the output voltage slightly higher than the nominal output voltage during PWM operation, allowing additional headroom for voltage drop during a load transient from light to heavy load. The PFM comparators sense the output voltage via the feedback pin and control the switching of the output FETs such that the output voltage ramps between 0.8% and 1.6% (typical) above the nominal PWM output voltage. If the output voltage is below the 'high' PFM comparator threshold, the PFET power switch is turned on. It remains on until the output voltage exceeds the 'high' PFM threshold or the peak current exceeds the  $I_{PFM}$  level set for PFM mode. The typical peak current in PFM mode is:

$$I_{PFM} = 115 \text{ mA} + V_{IN}/57\Omega$$

Once the PFET power switch is turned off, the NFET power switch is turned on until the inductor current ramps to zero. When the NFET zero-current condition is detected, the NFET power switch is turned off. If the output voltage is below the 'high' PFM comparator threshold (see *Figure 5*), the PFET switch is again turned on and the cycle is repeated until the output reaches the desired level. Once the output reaches the 'high' PFM threshold, the NFET switch is turned on briefly to ramp the inductor current to zero and then both output switches are turned off and the part enters an extremely low power mode.

**FORCED PWM MODE**

The LM3370 auto mode can be bypassed by forcing the device to operate in PWM mode, this can be implemented through the I<sup>2</sup>C compatible interface, see *Table 1*.

**SOFT-START**

The LM3370 has a soft start circuit that limits in-rush current during start up. Soft start is activated only if EN goes from logic low to logic high after V<sub>IN</sub> reaches 2.7V.

**LDO - LOW DROP OUT OPERATION**

The LM3370 can operate at 100% duty cycle (no switching, PFET switch completely on) for low drop out support of the

output voltage. In this way the output voltage will be controlled down to the lowest possible input voltage. The minimum input voltage needed to support the output voltage is  $V_{IN,MIN} = I_{LOAD} * (R_{DS(on),PFET} + R_{INDUCTOR}) + V_{OUT}$

- I<sub>LOAD</sub> load current
- R<sub>DS(on)/PFET</sub> drain to source resistance of PFET switch in the triode region
- R<sub>INDUCTOR</sub> inductor resistance

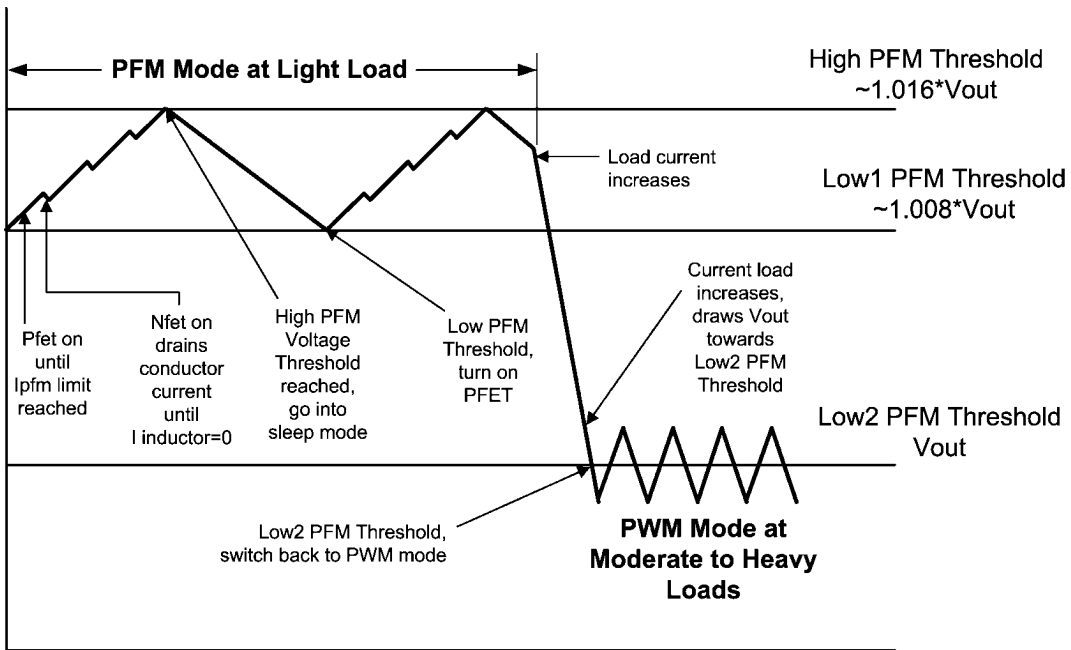

20167303

**FIGURE 5. Operation in PFM Mode and Transfer to PWM Mode**

## I<sup>2</sup>C Compatible Interface Electrical Specifications

Unless otherwise noted,  $V_{BATT} = 2.7V$  to  $5.5V$ . Typical values and limits appearing in normal type apply for  $T_j = 25^\circ C$ . Limits appearing in **boldface** type apply over the entire junction temperature range for operation,  $-30^\circ C$  to  $+125^\circ C$ . (Notes 2, 8, 9)

Symbol	Parameter	Conditions	Min	Typ	Max	Units
$F_{CLK}$	Clock Frequency				400	kHz
$t_{BF}$	Bus-Free Time between Start and Stop	(Note 10)	<b>1.3</b>			$\mu S$
$t_{HOLD}$	Hold Time Repeated Start Condition	(Note 10)	<b>0.6</b>			$\mu S$
$t_{CLKLP}$	CLK Low Period	(Note 10)	<b>1.3</b>			$\mu S$
$t_{CLKHP}$	CLK High Period	(Note 10)	<b>0.6</b>			$\mu S$
$t_{SU}$	Set Up Time Repeated Start Condition	(Note 10)	<b>0.6</b>			$\mu S$
$t_{DATAHLD}$	Data Hold Time	(Note 10)	<b>200</b>			nS
$t_{CLKSU}$	Data Set Up Time	(Note 10)	<b>200</b>			nS
$T_{SU}$	Set Up Time for Start Condition	(Note 10)	<b>0.6</b>			$\mu S$
$T_{TRANS}$	Maximum Pulse Width of Spikes that Must be Suppressed by the Input Filter of Both DATA & CLK signals.	(Note 10)		50		nS
$VDD_{I2C}$	I <sup>2</sup> C Logic High Level		1		$V_{IN}$	V

### I<sup>2</sup>C Compatible Interface

In I<sup>2</sup>C compatible mode, the SCL pin is used for the I<sup>2</sup>C clock and the SDA pin is used for the I<sup>2</sup>C data. Both these signals need a pull-up resistor according to I<sup>2</sup>C specification. The values of the pull-up resistor are determined by the capacitance of the bus (typ.  $\sim 1.8k$ ). Signal timing specifications are

according to the I<sup>2</sup>C bus specification. Maximum frequency is 400 kHz.

#### I<sup>2</sup>C COMPATIBLE DATA VALIDITY

The data on SDA line must be stable during the HIGH period of the clock signal (SCL). In other words, state of the data line can only be changed when CLK is LOW.

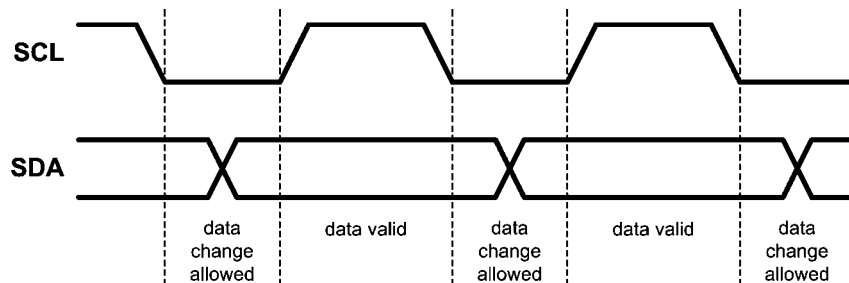

#### I<sup>2</sup>C COMPATIBLE START AND STOP CONDITIONS

START and STOP bits classify the beginning and the end of the I<sup>2</sup>C session. START condition is defined as SDA signal transitioning from HIGH to LOW while SCL line is HIGH. STOP condition is defined as the SDA transitioning from LOW to HIGH while SCL is HIGH. The I<sup>2</sup>C master always generates

START and STOP bits. The I<sup>2</sup>C bus is considered to be busy after START condition and free after STOP condition. During data transmission, I<sup>2</sup>C master can generate repeated START conditions. First START and repeated START conditions are equivalent, function-wise.

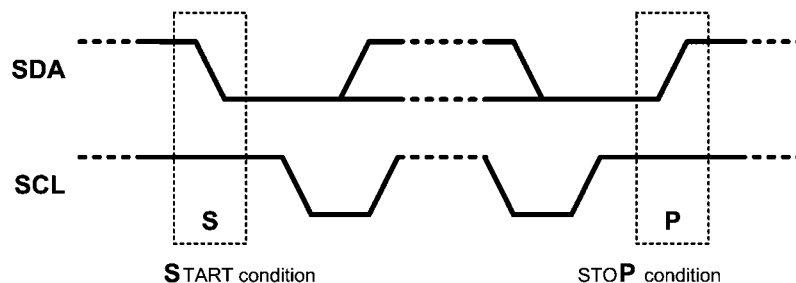



**TRANSFERRING DATA**

Every byte put on the SDA line must be eight bits long, with the most significant bit (MSB) being transferred first. The number of bytes that can be transmitted per transfer is unrestricted. Each byte of data has to be followed by an acknowledge bit. The acknowledge related clock pulse is generated by the master. The transmitter releases the SDA line (HIGH) during the acknowledge clock pulse. The receiver must pull down the SDA line during the 9th clock pulse, signifying an

acknowledge. A receiver which has been addressed must generate an acknowledge after each byte has been received. After the START condition, I<sup>2</sup>C master sends a chip address. This address is seven bits long followed by an eighth bit which is a data direction bit (R/W). For the eighth bit, a "0" indicates a WRITE and a "1" indicates a READ. The second byte selects the register to which the data will be written. The third byte contains data to write to the selected register.

**I<sup>2</sup>C Compatible Write Cycle**

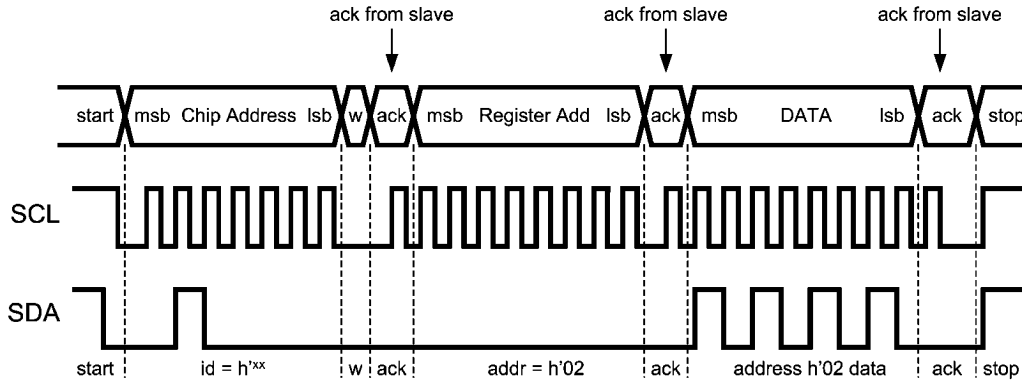

20167309

- W = write (SDA = "0")
- r = read (SDA = "1")
- ack = acknowledge (SDA pulled down by either master or slave)
- rs = repeated startxx=36h

However, if a READ function is to be accomplished, a WRITE function must precede the READ function, as shown in the read cycle waveform.

**I<sup>2</sup>C Compatible Read Cycle**

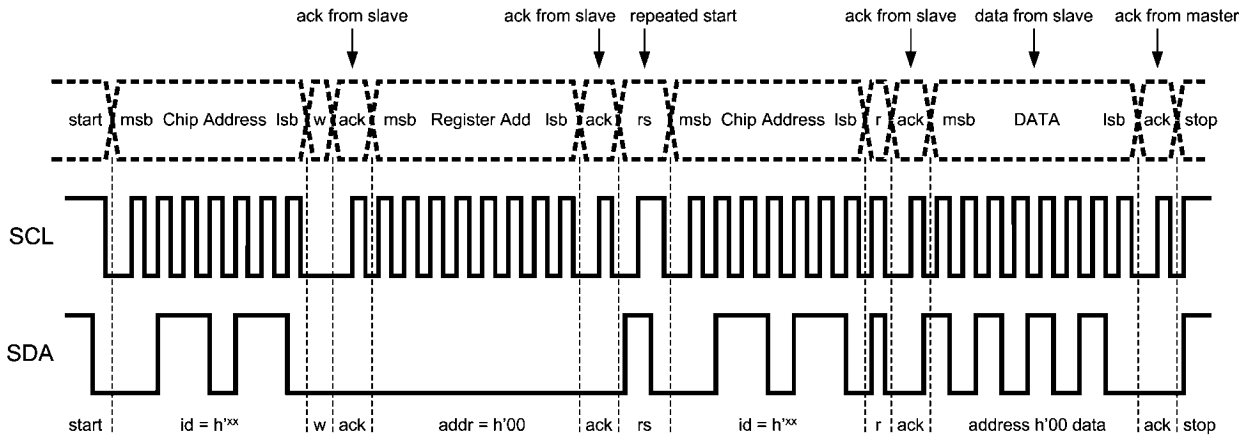

20167310

# Device Register Information

## Register Information

Register Name	Location	Type	Function
Control	00	R/W	Control signal for Buck 1 and Buck 2
Buck 1	01	R/W	Output setting & Mode selection for Buck 1
Buck 2	02	R/W	Output setting & Mode selection for Buck 2 and POR disable

### I<sup>2</sup>C CHIP ADDRESS INFORMATION

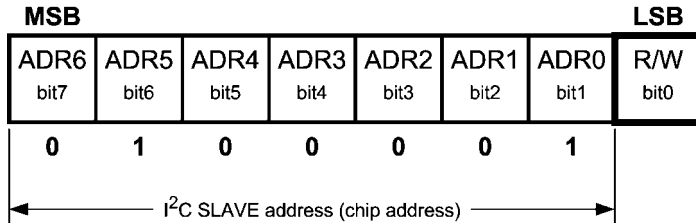

20167308

### REGISTER 00

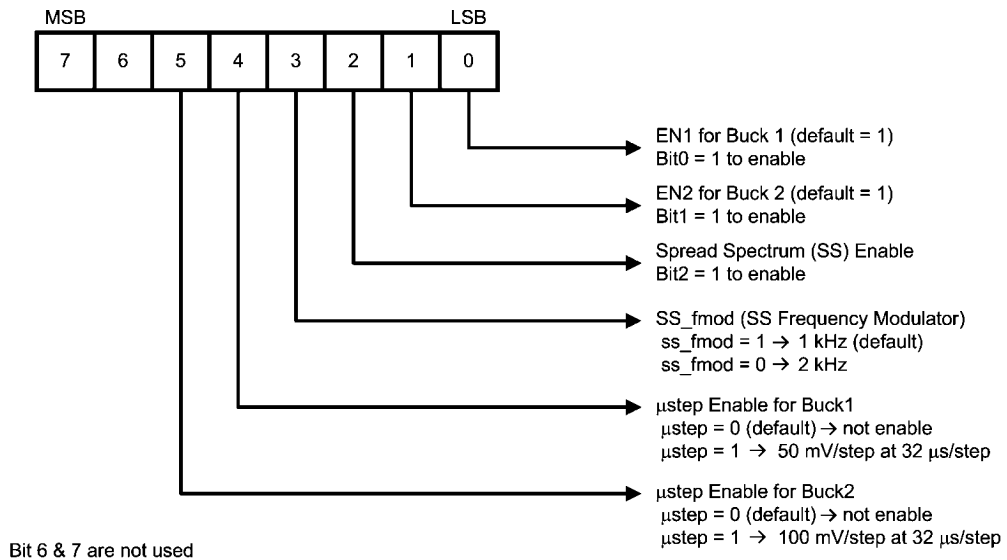

20167311

## REGISTER 01

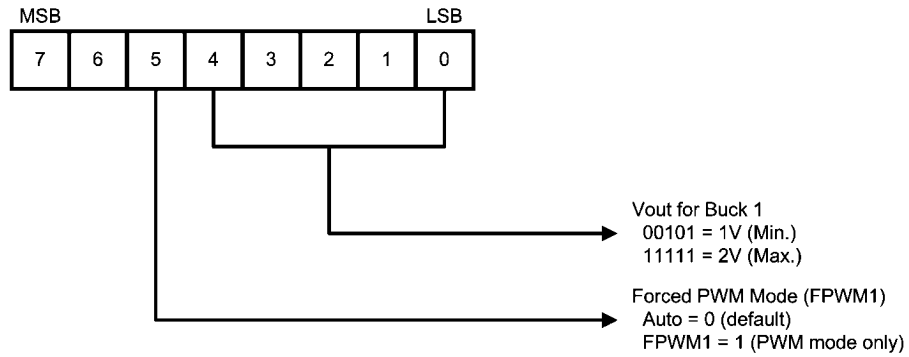

Bit 6 and 7 are not used

20167312

## REGISTER 02

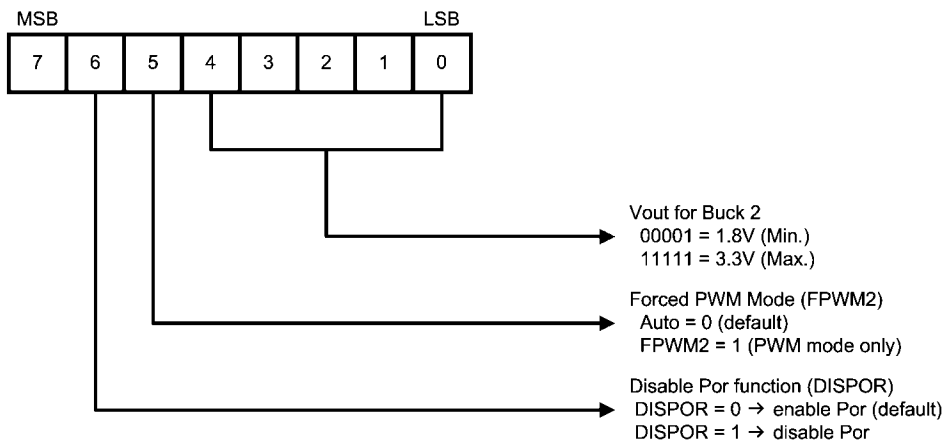

Bit 7 is not used

20167313

**TABLE 1. Output Selection Table via I<sup>2</sup>C Programming**

Buck Output Voltage Selection Codes		
Data Code	Buck_1 (V)	Buck_2 (V)
00000	NA	NA
00001	NA	1.8
00010	NA	1.85 or 1.9*
00011	NA	2.0
00100	NA	2.1
00101	1.00	2.2
00110	1.05	2.3
00111	1.10	2.4
01000	1.15	2.5
01001	1.20	2.6
01010	1.25	2.7
01011	1.30	2.8
01100	1.35	2.9
01101	1.40	3.0
01110	1.45	3.1
01111	1.50	3.2
10000	1.55	3.3
10001	1.60	NA
10010	1.65	NA
10011	1.70	NA
10100	1.75	NA
10101	1.80	NA
10110	1.85	NA
10111	1.90	NA
11000	1.95	NA
11001	2.00	NA

\* Can be trimmed at the factory at 1.85V or 1.9V using the same trim code.

## Application Information

### SETTING OUTPUT VOLTAGE VIA I<sup>2</sup>C Compatible

The outputs of the LM3370 can be programmed through Buck 1 & Buck 2 registers via I<sup>2</sup>C. Buck 1 output voltage can be dynamically adjusted between 1V to 2V in 50 mV steps and Buck 2 output voltage can be adjusted between 1.8V to 3.3V in 100 mV steps. Finer adjustments to the output of Buck 2 can be achieved with the placement of a resistor between V<sub>OUT2</sub> and the FB2 pin. Typically by placing a 20KΩ resistor, R, between these nodes will result in the programmed Output Voltage increasing by approximately 45mV, ΔV<sub>TYP</sub>.

$$\Delta V_{TYP} = R \times 500\text{mV} / 234\text{K}\Omega$$

Please refer to for programming the desire output voltage. If the I<sup>2</sup>C compatible feature is not used, the default output voltage will be the pre-trimmed voltage. For example, LM3370SD-3021 refers to 1.2V for Buck 1 and 3.3V for Buck 2.

### V<sub>DD</sub> Pin

V<sub>DD</sub> is the power supply to the internal control circuit, if V<sub>DD</sub> pin is not tied to V<sub>IN</sub> during normal operating condition, V<sub>DD</sub> must be set equal or greater of the two inputs (V<sub>IN1</sub> or V<sub>IN2</sub>). An optional capacitor can be used for better noise immunity at V<sub>DD</sub> pin or when V<sub>DD</sub> is not tied to either V<sub>IN</sub> pins. Additionally, for reasons of noise suppression, it is advisable to tie the EN1/EN2 pins to V<sub>DD</sub> rather than V<sub>IN</sub>.

### SDA, SCL Pins

When not using I<sup>2</sup>C the SDA and SCL pins should be tied directly to the V<sub>DD</sub> pin.

### Micro-Stepping:

The Micro-Stepping feature minimizes output voltage overshoot/undershoot during large output transients. If Micro-stepping is enabled through I<sup>2</sup>C, the output voltage automatically ramps at 50 mV per step for Buck 1 and 100 mV per step for Buck 2. The steps are summarized as follow:

Buck 1: 50 mV/step and 32 μs/step

Buck 2: 100 mV/step and 32 μs/step

For example if changing Buck 1 voltage from 1V to 1.8V yields 20 steps [(1.8 - 1) / 0.05 = 20]. This translates to 640μs [(20 x 32 μs) = 640 μs] needed to reach the final target voltage.

### INDUCTOR SELECTION

There are two main considerations when choosing an inductor; the inductor should not saturate, and the inductor current ripple is small enough to achieve the desired output voltage ripple.

There are two methods to choose the inductor current rating.

#### method 1:

The total current is the sum of the load and the inductor ripple current. This can be written as

$$\begin{aligned} I_{MAX} &= I_{LOAD} + \left( \frac{I_{RIPPLE}}{2} \right) \\ &= I_{LOAD} + \left( \frac{V_{IN} - V_{OUT}}{2 * L} \right) * \left( \frac{V_{OUT}}{V_{IN}} \right) * \left( \frac{1}{f} \right) \end{aligned}$$

- I<sub>LOAD</sub> load current
- V<sub>IN</sub> input voltage
- L inductor
- f switching frequency

#### method 2:

A more conservative approach is to choose an inductor that can handle the maximum current limit of 1400 mA.

Given a peak-to-peak current ripple (I<sub>PP</sub>) the inductor needs to be at least

$$L \geq \left( \frac{V_{IN} - V_{OUT}}{I_{PP}} \right) * \left( \frac{V_{OUT}}{V_{IN}} \right) * \left( \frac{1}{f} \right)$$

A 2.2 μH inductor with a saturation current rating of at least 1400 mA is recommended for most applications. The inductor's resistance should be less than around 0.2Ω for good efficiency. Table 2 lists suggested inductors and suppliers.

For low-cost applications, an unshielded bobbin inductor is suggested. For noise critical applications, a toroidal or shielded-bobbin inductor should be used. A good practice is to lay out the board with overlapping footprints of both types for design flexibility. This allows substitution of a low-noise toroidal inductor, in the event that noise from low-cost bobbin models is unacceptable.

Below are some suggested inductor manufacturers include but are not limited to:

TABLE 2. Suggested Inductors and Suppliers

Model	Vendor	Dimensions (mm)	I <sub>SAT</sub>
DO3314-222	Coilcraft	3.3 x 3.3 x 1.4	1.6A
LPO3310-222		3.3 x 3.3 x 1.0	1.1A
SD3114-2R2	Cooper	3.1 x 3.1 x 1.4	1.48A
NR3010T2R2M	Taiyo Yuden	3.0 x 3.0 x 1.0	1.1A
NR3015T2R2M		3.0 x 3.0 x 1.5	1.48A
VLF3010AT-2R2M1R0	TDK	2.6 x 2.8 x 1.0	1.0A

### INPUT CAPACITOR SELECTION

A ceramic input capacitor of 4.7 μF, 6.3V is sufficient for most applications. A larger value may be used for improved input voltage filtering. The input filter capacitor supplies current to the PFET switch of the LM3370 in the first half of each cycle and reduces voltage ripple imposed on the input power source. A ceramic capacitor's low ESR provides the best noise filtering of the input voltage spikes due to this rapidly changing current. Select an input filter capacitor with a surge current rating sufficient for the power-up surge from the input power source. The power-up surge current is approximately the capacitor's value (μF) times the voltage rise rate (V/μs).

The input current ripple can be calculated as:

$$I_{RMS} = I_{OUTMAX} * \sqrt{\frac{V_{OUT}}{V_{IN}} * \left( 1 - \frac{V_{OUT}}{V_{IN}} \right)}$$

The worst case IRMS is:

$$I_{RMS} = \frac{I_{OUTMAX}}{2} \quad (\text{duty cycle} = 50\%)$$

### OUTPUT CAPACITOR SELECTION

DC bias characteristics of ceramic capacitors must be considered when selecting case sizes like 0805 and 0603. DC

bias characteristics vary from manufacturer to manufacturer and dc bias curves should be requested from them as part of the capacitor selection process.

The output filter capacitor smoothes out current flow from the inductor to the load, helps maintain a steady output voltage during transient load changes and reduces output voltage ripple. These capacitors must be selected with sufficient capacitance and sufficiently low ESR to perform these functions. The output ripple voltage can be calculated as:

Voltage peak-to-peak ripple due to capacitance =

$$V_{PP-C} = \frac{I_{PP}}{f \cdot 8 \cdot C}$$

Voltage peak-to-peak ripple due to ESR =  $V_{PP-ESR} = I_{PP} \cdot R_{ESR}$

Voltage peak-to-peak ripple, root mean squared =

$$V_{PP-RMS} = \sqrt{V_{PP-C}^2 + V_{PP-ESR}^2}$$

Note that the output ripple is dependent on the current ripple and the equivalent series resistance of the output capacitor ( $R_{ESR}$ ). The  $R_{ESR}$  is frequency dependent (as well as temperature dependent); make sure that the frequency of the  $R_{ESR}$  given is the same order of magnitude as the switching frequency.

**TABLE 3. Suggested Capacitors and Their Suppliers**

Model	Description	Case Size	Vendor
<b>4.7 <math>\mu\text{F}</math> for <math>C_{IN}</math></b>			
C1608X5R0J475	Ceramic, X5R, 6.3V Rating	0603	TDK
C2012X5R0J475	Ceramic, X5R, 6.3V Rating	0805	
JMK212BJ475	Ceramic, X5R, 6.3V Rating	0805	Taiyo Yuden
GRM21BR60J475	Ceramic, X5R, 6.3V Rating	0805	
GRM219R60J-475KE19D	Ceramic, X5R, 6.3V Rating	0805 (Thin) <1mm Height	muRata
<b>10<math>\mu\text{F}</math> <math>C_{OUT}</math></b>			
C2012X5R0J106	Ceramic, X5R, 6.3V Rating	0805	TDK
JMK212BJ106	Ceramic, X5R, 6.3V Rating	0805	Taiyo Yuden
GRM21BR60J106	Ceramic, X5R, 6.3V Rating	0805	
GRM219R60J-106KE19D	Ceramic, X5R, 6.3V Rating	0805 (Thin) < 1mm Height	muRata

### POR (POWER ON RESET)

The LM3370 has an independent POR functions (nPOR) for each buck converter. The nPOR1 and nPOR2 are open drain circuits which pull low when the outputs are below 94% (rising

$V_{OUT}$ ) or 85% (falling  $V_{OUT}$ ) of the desired output. The inherent delay between the output (at 94% of  $V_{OUT}$ ) to the time at which the nPOR is enabled is about 50 ms. A pull up resistor of 100 k $\Omega$  at nPOR pin is required. Please refer to the electrical specification table for other timing options. The diagram below illustrates the timing response of the POR function.

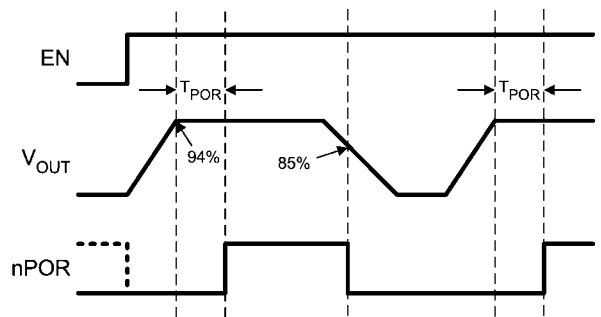

20167319

### SPREAD SPECTRUM (SS)

The LM3370 features Spread Spectrum capability, via I<sup>2</sup>C, to reduce the noise amplitude of the switching frequency during data transmission. The feature can be enabled by activating the appropriate control register bit (see register information section for detail). The main clock of the LM3370 features spread spectrum at  $F_{OSC} = 2 \text{ MHz} \pm 22 \text{ kHz}$  (peak frequency deviation) with the modulation frequency of either 1 kHz (default) or 2 kHz via I<sup>2</sup>C. This helps reduce noise caused by the harmonics present in the waveforms at the switch pins of the buck regulators. It is controlled by I<sup>2</sup>C in the following manner:

I <sup>2</sup> C bit	Modulation Frequency
SS_fmmod = 1 (default)	1 kHz
SS_fmmod = 0	2 kHz

### BOARD LAYOUT CONSIDERATIONS

PC board layout is an important part of DC-DC converter design. Poor board layout can disrupt the performance of a DC-DC converter and surrounding circuitry by contributing to EMI, ground bounce, and resistive voltage loss in the traces. These can send erroneous signals to the DC-DC converter IC, resulting in poor regulation or instability.

Good layout for the LM3370 can be implemented by following a few simple design rules:

1. *Place the LM3370, inductor and filter capacitors close together and make the traces short.* The traces between these components carry relatively high switching currents and act as antennas. Following this rule reduces radiated noise. Place the capacitors and inductor within 0.2 in. (5mm) of the LM3370.
2. *Arrange the components so that the switching current loops curl in the same direction.* During the first half of each cycle, current flows from the input filter capacitor, through the LM3370 and inductor to the output filter capacitor and back through ground, forming a current loop. In the second half of each cycle, current is pulled up from ground, through the LM3370 by the inductor, to the output filter capacitor and then back through ground, forming a second current loop. Routing these loops so the current curls in the same direction prevents magnetic field reversal between the two half-cycles and reduces radiated noise.
3. *Connect the ground pins of the LM3370, and filter capacitors together using generous component-side*

*copper fill as a pseudo-ground plane. Then, connect this to the ground-plane (if one is used) with several vias. This reduces ground-plane noise by preventing the switching currents from circulating through the ground plane. It also reduces ground bounce at the LM3370 by giving it a low-impedance ground connection.*

4. *Use wide traces between the power components and for power connections to the DC-DC converter circuit. This reduces voltage errors caused by resistive losses across the traces.*
5. *Route noise sensitive traces, such as the voltage feedback path, away from noisy traces between the power components. The voltage feedback trace must remain close to the LM3370 circuit and should be direct but should be routed opposite to noisy components. This reduces EMI radiated onto the DC-DC converter's own voltage feedback trace.*
6. *Place noise sensitive circuitry, such as radio IF blocks, away from the DC-DC converter, CMOS digital blocks and other noisy circuitry. Interference with noise-sensitive circuitry in the system can be reduced through distance.*

In mobile phones, for example, a common practice is to place the DC-DC converter on one corner of the board, arrange the CMOS digital circuitry around it (since this also generates noise), and then place sensitive preamplifiers and IF stages on the diagonally opposing corner. Often, the sensitive circuitry is shielded with a metal pan and power to it is post-regulated to reduce conducted noise, using low-dropout linear regulators.

#### **Micro SMD PACKAGE ASSEMBLY AND USE**

Use of the Micro SMD package requires specialized board layout, precision mounting and careful re-flow techniques, as detailed in National Semiconductor Application Note 1112.

Refer to the section "Surface Mount Technology (SMD) Assembly Considerations". For best results in assembly, alignment ordinals on the PC board should be used to facilitate placement of the device. The pad style used with Micro SMD package must be the NSMD (non-solder mask defined) type. This means that the solder-mask opening is larger than the pad size. This prevents a lip that otherwise forms if the solder-mask and pad overlap, from holding the device off the surface of the board and interfering with mounting. See Application Note 1112 for specific instructions how to do this. The 20-Bump package used for LM3370TL has 300 micron solder balls and requires 10.82 mils pads for mounting on the circuit board. The trace to each pad should enter the pad with a 90° entry angle to prevent debris from being caught in deep corners. Initially, the trace to each pad should be 7 mil wide, for a section approximately 7 mil long or longer, as a thermal relief. Then each trace should neck up or down to its optimal width. The important criteria is symmetry. This ensures the solder bumps on the LM3370TL re-flow evenly and that the device solders level to the board. In particular, special attention must be paid to the pads for bumps A2/B1 of  $V_{OUT1}$ , and E2/D1 of  $V_{OUT2}$ , because  $V_{IN}$  and PGND are typically connected to large copper planes, inadequate thermal relief can result in late or inadequate re-flow of these bumps.

The Micro SMD package is optimized for the smallest possible size in applications with red or infrared opaque cases. Because the Micro SMD package lacks the plastic encapsulation characteristic of larger devices, it is vulnerable to light. Backside metallization and/or epoxy coating, along with front-side shading by the printed circuit board, reduce this sensitivity. However, the package has exposed die edges. In particular, Micro SMD devices are sensitive to light, in the red and infrared range, shining on the package's exposed die edges.

**Physical Dimensions** inches (millimeters) unless otherwise noted

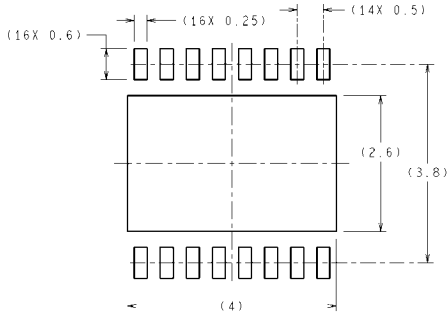

DIMENSIONS ARE IN MILLIMETERS  
DIMENSIONS IN ( ) FOR REFERENCE ONLY

RECOMMENDED LAND PATTERN

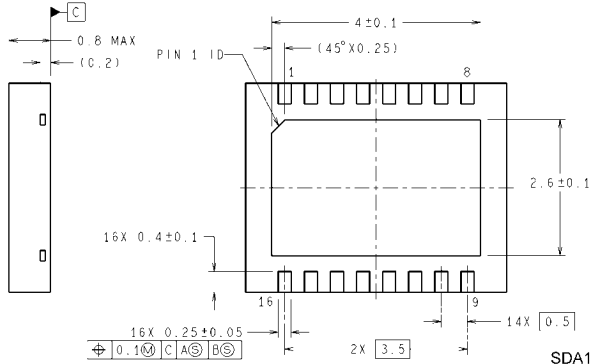
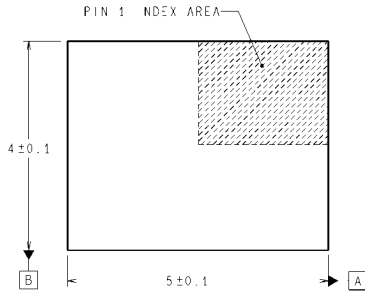

SDA16B (Rev A)

**NOTES: UNLESS OTHERWISE SPECIFIED**

1. For solder thickness and composition, see "Solder Information" in the packaging section of the National Semiconductor Web Page ([www.national.com](http://www.national.com))
2. Maximum allowable metal burn on lead tips at the package edges is 76 microns.
3. No JEDEC registration as of December 2004.

**16-Lead LLP Package**  
**NS Package Number SDA16B**  
**4 mm x 5 mm x 0.75 mm**



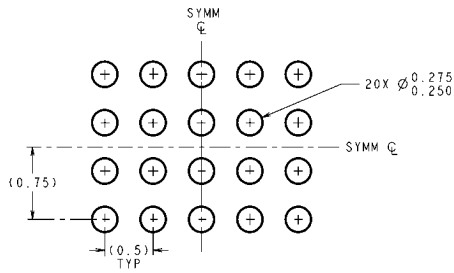

DIMENSIONS ARE IN MILLIMETERS  
DIMENSIONS IN ( ) FOR REFERENCE ONLY

LAND PATTERN RECOMMENDATION

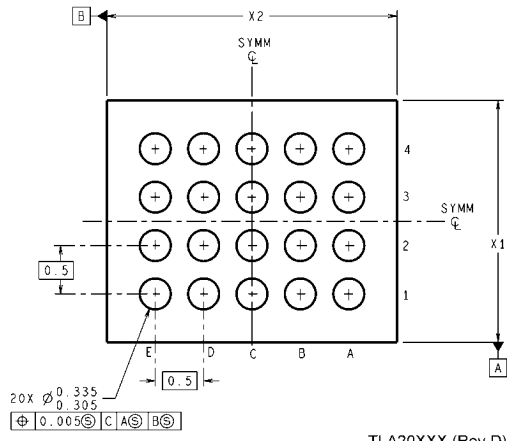
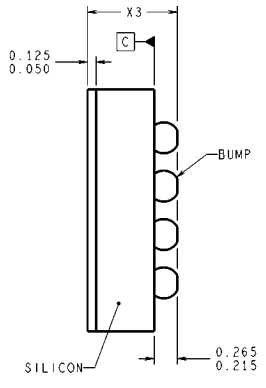
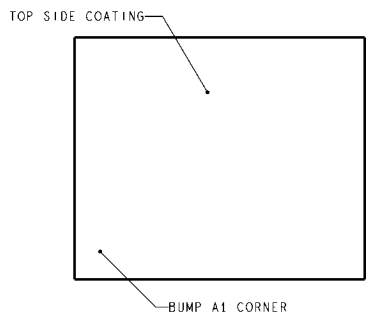

TLA20XXX (Rev D)

NOTE: UNLESS OTHERWISE SPECIFIED

1. EPOXY COATING
2. FOR SOLDER BUMP COMPOSITION, SEE "SOLDER INFORMATION" IN THE PACKAGE SECTION OF THE NATIONAL SEMICONDUCTOR WEB PAGE (www.national.com)
3. RECOMMEND NON-SOLDER MASK DEFINED LANDING PAD.
4. PIN A1 IS ESTABLISHED BY LOWER LEFT CORNER WITH RESPECT TO TEXT ORIENTATION.
5. XXX IN DRAWING NUMBER REPRESENTS PACKAGE SIZE VARIATION WHERE X1 IS PACKAGE WIDTH, X2 IS PACKAGE LENGTH AND X3 IS PACKAGE HEIGHT.
6. REFERENCE JEDEC REGISTRATION MO-211, VARIATION DG.

**20-Bump micro SMD Package, 0.5mm Pitch**  
**NS Package Number TLA20CWA**  
**X1 = 2.047 mm ± 0.030 mm**  
**X2 = 3.000 mm ± 0.030 mm**  
**X3 = 0.600 mm ± 0.075 mm**

## Notes

For more National Semiconductor product information and proven design tools, visit the following Web sites at:

Products		Design Support	
Amplifiers	<a href="http://www.national.com/amplifiers">www.national.com/amplifiers</a>	WEBENCH	<a href="http://www.national.com/webench">www.national.com/webench</a>
Audio	<a href="http://www.national.com/audio">www.national.com/audio</a>	Analog University	<a href="http://www.national.com/AU">www.national.com/AU</a>
Clock Conditioners	<a href="http://www.national.com/timing">www.national.com/timing</a>	App Notes	<a href="http://www.national.com/appnotes">www.national.com/appnotes</a>
Data Converters	<a href="http://www.national.com/adc">www.national.com/adc</a>	Distributors	<a href="http://www.national.com/contacts">www.national.com/contacts</a>
Displays	<a href="http://www.national.com/displays">www.national.com/displays</a>	Green Compliance	<a href="http://www.national.com/quality/green">www.national.com/quality/green</a>
Ethernet	<a href="http://www.national.com/ethernet">www.national.com/ethernet</a>	Packaging	<a href="http://www.national.com/packaging">www.national.com/packaging</a>
Interface	<a href="http://www.national.com/interface">www.national.com/interface</a>	Quality and Reliability	<a href="http://www.national.com/quality">www.national.com/quality</a>
LVDS	<a href="http://www.national.com/lvds">www.national.com/lvds</a>	Reference Designs	<a href="http://www.national.com/refdesigns">www.national.com/refdesigns</a>
Power Management	<a href="http://www.national.com/power">www.national.com/power</a>	Feedback	<a href="http://www.national.com/feedback">www.national.com/feedback</a>
Switching Regulators	<a href="http://www.national.com/switchers">www.national.com/switchers</a>		
LDOs	<a href="http://www.national.com/lido">www.national.com/lido</a>		
LED Lighting	<a href="http://www.national.com/led">www.national.com/led</a>		
PowerWise	<a href="http://www.national.com/powerwise">www.national.com/powerwise</a>		
Serial Digital Interface (SDI)	<a href="http://www.national.com/sdi">www.national.com/sdi</a>		
Temperature Sensors	<a href="http://www.national.com/tempsensors">www.national.com/tempsensors</a>		
Wireless (PLL/VCO)	<a href="http://www.national.com/wireless">www.national.com/wireless</a>		

THE CONTENTS OF THIS DOCUMENT ARE PROVIDED IN CONNECTION WITH NATIONAL SEMICONDUCTOR CORPORATION ("NATIONAL") PRODUCTS. NATIONAL MAKES NO REPRESENTATIONS OR WARRANTIES WITH RESPECT TO THE ACCURACY OR COMPLETENESS OF THE CONTENTS OF THIS PUBLICATION AND RESERVES THE RIGHT TO MAKE CHANGES TO SPECIFICATIONS AND PRODUCT DESCRIPTIONS AT ANY TIME WITHOUT NOTICE. NO LICENSE, WHETHER EXPRESS, IMPLIED, ARISING BY ESTOPPEL OR OTHERWISE, TO ANY INTELLECTUAL PROPERTY RIGHTS IS GRANTED BY THIS DOCUMENT.

TESTING AND OTHER QUALITY CONTROLS ARE USED TO THE EXTENT NATIONAL DEEMS NECESSARY TO SUPPORT NATIONAL'S PRODUCT WARRANTY. EXCEPT WHERE MANDATED BY GOVERNMENT REQUIREMENTS, TESTING OF ALL PARAMETERS OF EACH PRODUCT IS NOT NECESSARILY PERFORMED. NATIONAL ASSUMES NO LIABILITY FOR APPLICATIONS ASSISTANCE OR BUYER PRODUCT DESIGN. BUYERS ARE RESPONSIBLE FOR THEIR PRODUCTS AND APPLICATIONS USING NATIONAL COMPONENTS. PRIOR TO USING OR DISTRIBUTING ANY PRODUCTS THAT INCLUDE NATIONAL COMPONENTS, BUYERS SHOULD PROVIDE ADEQUATE DESIGN, TESTING AND OPERATING SAFEGUARDS.

EXCEPT AS PROVIDED IN NATIONAL'S TERMS AND CONDITIONS OF SALE FOR SUCH PRODUCTS, NATIONAL ASSUMES NO LIABILITY WHATSOEVER, AND NATIONAL DISCLAIMS ANY EXPRESS OR IMPLIED WARRANTY RELATING TO THE SALE AND/OR USE OF NATIONAL PRODUCTS INCLUDING LIABILITY OR WARRANTIES RELATING TO FITNESS FOR A PARTICULAR PURPOSE, MERCHANTABILITY, OR INFRINGEMENT OF ANY PATENT, COPYRIGHT OR OTHER INTELLECTUAL PROPERTY RIGHT.

### LIFE SUPPORT POLICY

**NATIONAL'S PRODUCTS ARE NOT AUTHORIZED FOR USE AS CRITICAL COMPONENTS IN LIFE SUPPORT DEVICES OR SYSTEMS WITHOUT THE EXPRESS PRIOR WRITTEN APPROVAL OF THE CHIEF EXECUTIVE OFFICER AND GENERAL COUNSEL OF NATIONAL SEMICONDUCTOR CORPORATION.** As used herein:

Life support devices or systems are devices which (a) are intended for surgical implant into the body, or (b) support or sustain life and whose failure to perform when properly used in accordance with instructions for use provided in the labeling can be reasonably expected to result in a significant injury to the user. A critical component is any component in a life support device or system whose failure to perform can be reasonably expected to cause the failure of the life support device or system or to affect its safety or effectiveness.

National Semiconductor and the National Semiconductor logo are registered trademarks of National Semiconductor Corporation. All other brand or product names may be trademarks or registered trademarks of their respective holders.

Copyright© 2008 National Semiconductor Corporation

For the most current product information visit us at [www.national.com](http://www.national.com)



**National Semiconductor  
Americas Technical  
Support Center**  
Email:  
[new.feedback@nsc.com](mailto:new.feedback@nsc.com)  
Tel: 1-800-272-9959

**National Semiconductor Europe  
Technical Support Center**  
Email: [europe.support@nsc.com](mailto:europe.support@nsc.com)  
German Tel: +49 (0) 180 5010 771  
English Tel: +44 (0) 870 850 4288

**National Semiconductor Asia  
Pacific Technical Support Center**  
Email: [ap.support@nsc.com](mailto:ap.support@nsc.com)

**National Semiconductor Japan  
Technical Support Center**  
Email: [jpn.feedback@nsc.com](mailto:jpn.feedback@nsc.com)